

Comparison of anodic dischargability of Li-B alloy with pure lithium in LiClO₄-propylene carbonate

S. D. JAMES

Naval Surface Weapons Centre, White Oak, Silver Spring, MD 20910, USA

Received 4 August 1981

The dischargability of Li-B alloy is comparable with that of pure lithium in PC-LiClO₄ at 23° C. The alloy may find a useful application where safety considerations permit sacrificing some coulombic capacity versus unsupported lithium. Electrochemical measurements of the amount of lithium anodically oxidized at the lithium potential suggest that the alloy is a mixture of elemental lithium plus a Li-B compound whose stoichiometry is in the vicinity of 'Li₇B₆'.

1. Introduction

Safety problems in both Li-SO₂ and the Li-SOCl₂ batteries have delayed the development of advanced weapons systems. The present work seeks to reduce this problem by using a Li-B alloy in place of pure lithium. The lithium-rich, Li-B alloys were first prepared at the Naval Surface Weapons Centre in 1972 [1]. They showed impressive performance as high-rate anodes in the molten LiCl-KCl eutectic between 400 and 600° C [2]. Many of the hazards of lithium batteries have been associated with the melting of lithium (at 180° C) in accidentally overheated cells. This problem should be considerably alleviated with Li-B anodes which retain their rigidity above 600° C. However, it is necessary to show that Li-B alloys can be discharged at room temperature at usefully high rates. In other words, does the inert boron component impede the discharge of the active lithium? Hence, the present work has characterized the anodic oxidation of Li-B alloy in LiClO₄-propylene carbonate (PC) solution at around 23° C as a function of the anodic current density.

2. Experimental procedure

2.1. Preparation of thin film test electrodes

The Li-B alloy preparation has been described [3]. In a dry room (below 3% rh) a 30 g ingot was pressed between sheets of polypropylene to a circu-

lar pancake about 2 mm × 95 mm. From this cake a number of 10 mm diameter (200 mg) discs were cut out with a cork-borer. These discs were then pressed onto stainless steel (SS304) circular plates (32 mm × 1.6 mm) which served as current collectors. The pressing operation (see Fig. 1) produced thin film (0.1-0.2 mm) anodes that could undergo complete discharge of their free lithium content in a reasonably short period of time. The Duke, Model 44-225 hydraulic press was capable of exerting a force of 25 ton. A key element in spreading thin alloy films over the 32 mm steel disc was the use of a deformable plastic disc above the Li-B alloy disc. When a rigid plastic (like polypropylene, PP) was used, 25 ton could not squeeze the alloy even to the steel periphery. However, a deformable plastic like conventional polyethylene (CPE) or nylon is itself squeezed out (irreversibly) and thereby effectively smears the alloy over the steel substrate. Three successive pressings using a force of 5 ton and a new plastic disc each time spread the alloy out well beyond the edge of the steel as shown in Fig. 1. The result is a 0.1-0.2 mm thick anode film firmly stuck to the steel. Excess alloy film (about 100 mg) was pared away from the steel periphery. A final light pressing below rigid PP gave a glossy smooth finish to the anode surface. Similar test anodes of pure lithium (Foote Mineral Co., 99%) were made to use as a standard by which to judge alloy discharge performance. With the much softer pure lithium, use of a deformable plastic in the pressing was unnecessary.

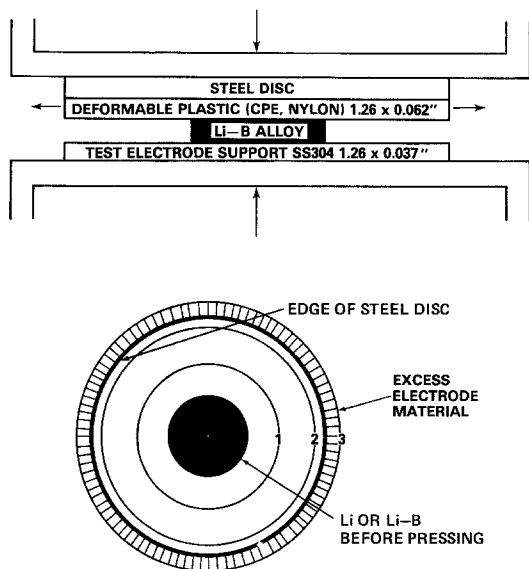

Fig. 1. Preparation of thin film test electrodes by three-stage pressing.

2.2. Discharge procedure

The Pyrex test-cell (Fig. 2) contained 100 cm³ of electrolyte under dry argon. Its cap was sealed via a Viton O-ring, pipe-joint. Stainless steel (SS304) was extensively used in the cell as counter-electrode, test electrode support and 1/8" (3.2 mm) rod leads to all three electrodes. The test electrode disc was clamped horizontally, slightly recessed into its holder and about 15 mm below the bare steel

counter electrode. Pure lithium, plastered over the threaded tip of an 1/8" SS304 rod served as a reference electrode. Heat-shrinkable polyolefin tubing masked off the steel surface of the reference electrode lead. All discharges used an electrolyte, 0.96 mol dm⁻³ LiClO₄ ('lithium perchlorate anhydrous' from Foote Mineral Co.) in propylene carbonate (Eastman 7050). Electrolyte was prepared in the dry room and stored in Pyrex in the presence of lithium ribbon. Discharge curves were recorded with a constant anodic current applied to the test electrode at ambient temperature (23 ± 1° C).

3. Results and discussion

Thermal measurements [3] have been made on the free lithium content of lithium-rich, Li-B alloys such as those discharged in the present work. The data showed that these alloys consisted of a refractory, Li-B compound (melting above 1000° C) having a stoichiometry in the vicinity of 'Li₇B₆'. Lithium in excess of 'Li₇B₆', in a free, elemental form is contained in fine pores permeating the refractory compound. At 500° C, most of this lithium is available for anodic discharge at rates up to 8 A cm⁻² at the lithium potential [2]. The compound behaves like a sponge and its liquid lithium wicks to the alloy-melt interface to be discharged. At room temperature the free lithium component is solid and rate capabilities of only mA cm⁻² are

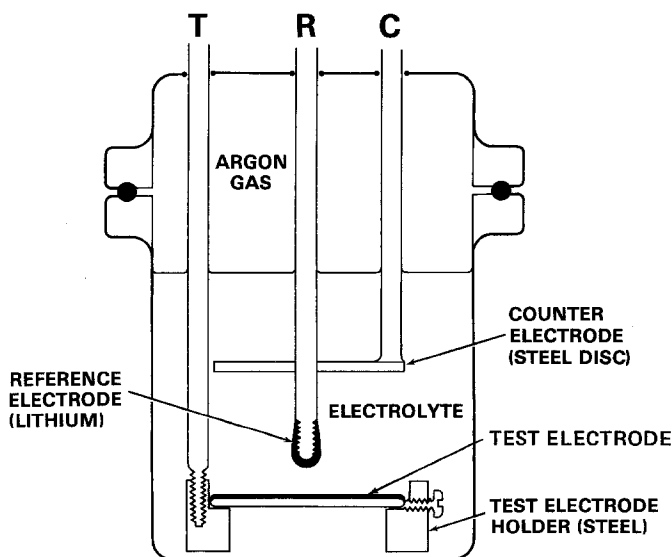

Fig. 2. Discharge cell.

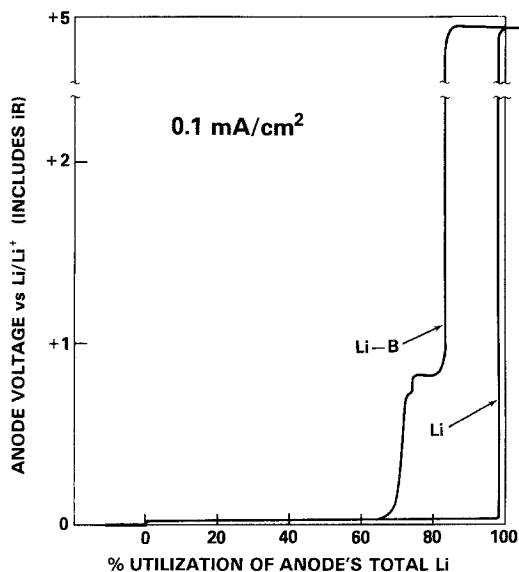

Fig. 3. Anodic discharge of Li and Li-B (80 at % Li) in 0.96 mol dm^{-3} LiClO₄-PC at 0.1 mA cm^{-2} and 23°C .

to be expected. The present work normally employed 80 at % Li (72 wt % Li) alloy except in one case (Fig. 4, 86 at % Li).

Figs 3-6 compare the dischargability of Li-B alloy with that of pure lithium at four anodic current densities ranging from 0.1 to 10 mA cm^{-2} . Where appropriate, anode voltage versus time is replotted as voltage versus per cent utilization of the anode's total lithium content (i.e. elemental lithium plus lithium chemically bound to boron). Generally speaking the data show that over a wide range of current densities the alloy behaves in a comparable manner to pure lithium in terms of both voltage and coulombic capacity. The final plateau at around $+5 \text{ V}$ (not included in Figs 5 and 6) is caused by anodic dissolution of the test electrode's steel substrate when lithium ionization can no longer support the imposed current.

The relative complexity of the Li-B curves in Figs 3-5 is due to the two-phase nature of the alloy as previously shown in molten salt discharges [2, 4]. On the main voltage-plateau at the lithium potential, free, elemental lithium is anodically dissolving. When all the available (or accessible) free lithium is used up, the voltage rises to a value where tighter-bound lithium can be anodized out of the decomposing compound. Subsequent inflections have been associated with the loss of further lithium giving rise to other Li-B compound stoichiometries.

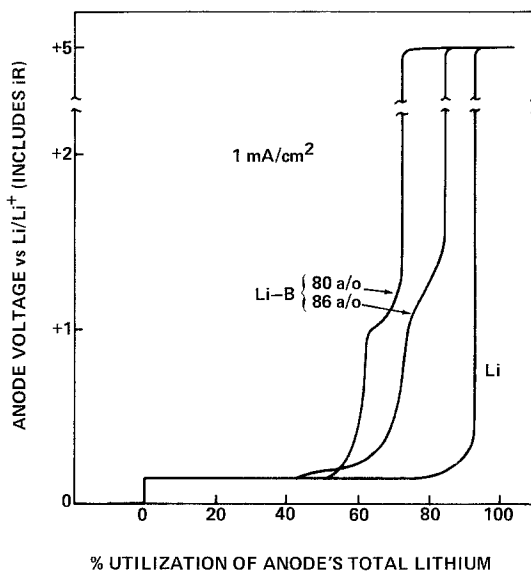

Fig. 4. Anodic discharge of Li and Li-B (80 and 86 at % Li) in 0.96 mol dm^{-3} LiClO₄-PC at 1 mA cm^{-2} and 23°C .

As the current density rises in Figs 3 to 6 the Li-B curves gradually lose their complexity until, at 10 mA cm^{-2} there is no boron-associated inflection at all. Apparently Li-B compound decomposition is too slow to generate sufficient lithium to maintain the higher currents, even briefly.

Fig. 7 shows percentage utilization of the anode's total lithium content to the first main inflection in the discharge curves of Figs 3-6. At 0.1 mA cm^{-2} , 100% of the pure lithium is usable anodically. Above 1 mA cm^{-2} , utilization falls sharply. Discharge is now ended not by complete consumption of lithium but by its superficial passivation. This takes the form of the sudden positive voltage excursion in Figs 3-6 terminating the anode's useful life. The nature of this polarization is presently under study. The Li-B alloy behaves similarly in Fig. 7 except it utilizes somewhat less of its lithium content. The value of 71% at 0.1 mA cm^{-2} probably reflects virtually complete consumption of the alloy's free lithium since pure lithium is 100% utilizable at this discharge rate. If an 80 at % (72 wt %) Li-B alloy consisted of a mixture of Li₇B₆ compound plus elemental lithium, this elemental lithium would comprise 71% of the alloy's total lithium. Thus, Fig. 7 supports the existence of 'Li₇B₆' in the Li-B system, agreeing with previous work in our laboratories [3, 5]. An unresolved conflict still exists between

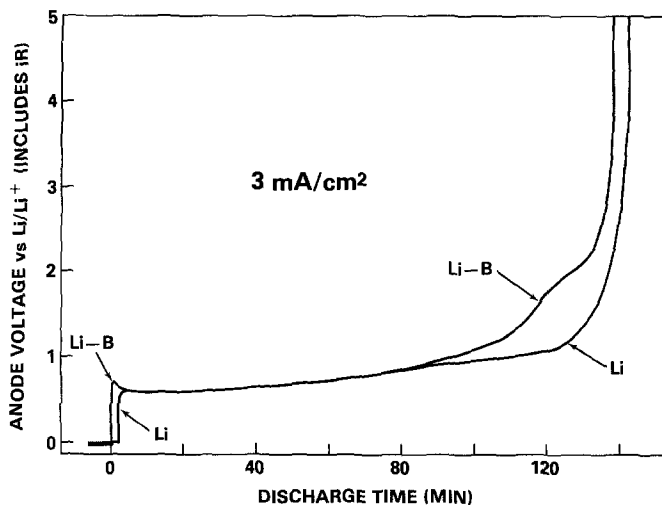

Fig. 5. Anodic discharge of Li and Li-B (80 at %) in $0.96 \text{ mol dm}^{-3} \text{ LiClO}_4\text{-PC}$ at 3 mA cm^{-2} and 23°C . Lithium curve displaced slightly for clarity.

these three studies and the earlier molten salt discharge [2] which strongly suggested the presence of Li_2B . The single discharge made with the lithium-rich, 86 at % alloy was at too high a rate (1 mA cm^{-2}) to yield stoichiometric information but its 10% higher lithium-utilization (versus the 80 at %) is consistent with the presence of ' Li_7B_6 ' (free lithium comprises 81% of total lithium in 86 at % alloy containing $\text{Li}_7\text{B}_6 + \text{Li}$).

Table 1 compares the discharge capacities of Li-B alloy and pure lithium at 1 mA cm^{-2} in propylene carbonate. The alloy has only 47 and 65% of the capacity of pure lithium on a gravimetric and volumetric basis, respectively. However, if lithium is supported in a rigid, refractory matrix like Li-B or Ni Feltmetal (FM) it is likely to be

safer in the event of a battery overheating and its lithium component melting. On a gravimetric and volumetric basis the alloy has 157 and 81% of the capacity of Li-FM. Furthermore, James and DeVries [2] showed that, between 400 and 600°C , lithium escapes significantly more slowly from Li-B than from Li-FM. Thus the Li-B alloy may find a useful application where safety considerations permit the sacrificing of some coulombic capacity, versus unsupported lithium.

4. Conclusions

1. Over a wide range of anodic current density, Li-B alloy behaves in a comparable manner to pure lithium in terms of the voltage and coulombic

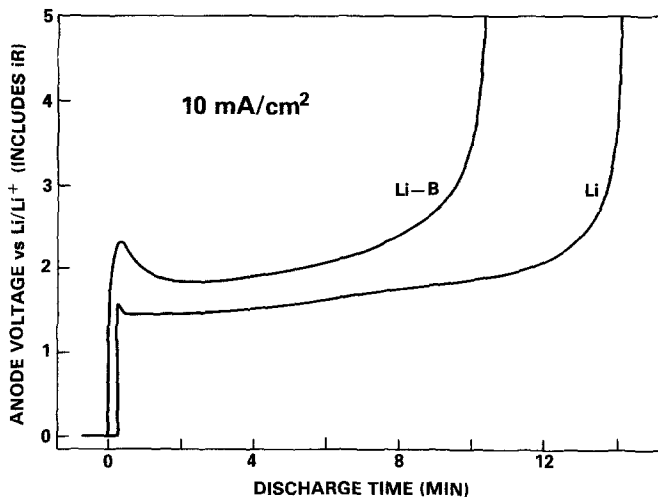

Fig. 6. Anodic discharge of Li and Li-B (80 at %) in $0.96 \text{ mol dm}^{-3} \text{ LiClO}_4\text{-PC}$ at 10 mA cm^{-2} and 23°C . Lithium curve displaced slightly for clarity.

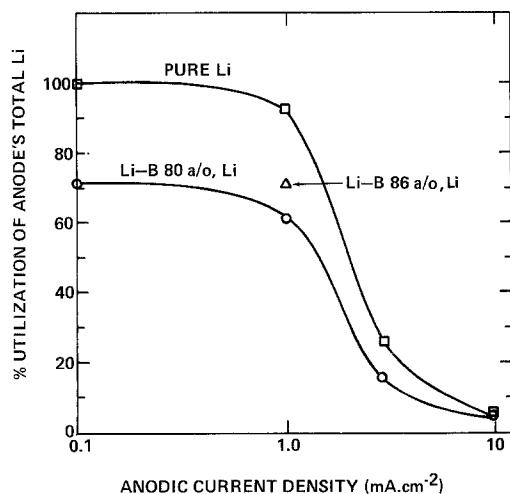

Fig. 7. Percentage anodic utilization of the total lithium (elemental plus chemically bound) in 0.2 mm thick films of lithium and Li-B (calculated at the first inflection of discharge curves in 0.96 mol dm⁻³ LiClO₄-PC at 23° C).

capacity of its discharge in PC-LiClO₄. Although somewhat inferior in coulombic capacity to pure lithium, the alloy is markedly superior to Li-Feltmetal, an alternative lithium vehicle.

2. Extrapolation of lithium utilizability to low discharge rate suggests that the Li-B alloy is a mixture of pure lithium and a Li-B compound whose stoichiometry is in the vicinity of 'Li₇B₆'.

Acknowledgements

We acknowledge the financial support of this work

Table 1. Useful coulombic capacities* at the lithium potential delivered by Li-B[†], Li-FM[‡] and pure lithium

	Anode (C cm ⁻³)	Anode (C g ⁻¹)
Li-B	4465	6 177
Li-FM	5500	3 900
Pure lithium	6905	12 930

* C cm⁻³ or g of (Li + B) for alloy and (Li + Ni) for Li-FM. Pure lithium and Li-B discharged (as thin films 0.1–0.2 mm) in 0.96 mol dm⁻³ LiClO₄-PC at 22° C. Capacity calculated at first main inflection of 1 mA cm⁻² discharge curves.

[†] Lithium content: 0.80 atom fraction; 0.72 mass fraction.

[‡] Lithium in 82% porous, 8 mm × 6 mm plugs of Ni-Feltmetal discharged at 500° C [2].

by the Independent Research Programme of the Naval Surface Weapons Centre and the help of Dr Steven Dallek with Li-B ingot preparation.

References

- [1] F. E. Wang, US Patent 4, 110, 111, (1978).
- [2] S. D. James and L. E. DeVries, *J. Electrochem. Soc.* **123** (1976) 321.
- [3] S. Dallek, D. W. Ernst and B. F. Larrick, *J. Electrochem. Soc.* **126** (1979) 866.
- [4] L. E. DeVries, L. D. Jackson and S. D. James, *J. Electrochem. Soc.* **126** (1979) 993.
- [5] W. P. Kilroy and I. Angres, *J. Less Common Met.* **63** (1979) 123.